

LOFT STYLE

Partitions & Doors



Loft Style

USING THE LOFT STYLE PRODUCTS



Loft Style Dynamik
Door Hinge

G.DK.LOFT.004



H-Type Door Frame

G.DK.SG.BK.006



Loft Style
Stick On
Grid Profile

G.DK.LOFT.005

Crystal Clear
Double Side
Acrylic Tape

HA7200.09.07



Magnetic Lever Lock
Frame Receiver

KLL501KF-B



Lock with knob





36x38mm Top &
Base Profile Gaskets
G.DK.AC.034



36x38mm
Top profile
G.DK.SG.BK.011



Loft Style
Door Perimeter
U Profile
G.DK.LOFT.001



Loft style Door
Perimeter - notched
U Profile Left
G.DK.LOFT.002



Small Magnetic Catch
Lever Lock Without Lock
KLL801M-B



Lever Handles
KLLD.DK.02.B



Vertical
Mullion
G.DK.LOFT.006



Stick On
Mullion
G.DK.LOFT.007



Crystal Clear
Double Side
Acrylic Tape
H.A7200.09.07



Packers for
Base Track
G.DK.AC.005



36x38mm
Top & Base
Profile Gaskets
G.DK.AC.034



36x38mm
Base profile
& cover
G.DK.SG.BK.012

Loft Style

26X28MM SINGLE GLAZED PARTITION SYSTEM

26x28mm Base Profile & Cover

Aluminium glass partition system for use on the bottom and side.

A two part system for very fast and easy installation. Gasket kits sold separately, dependent on glass thickness.

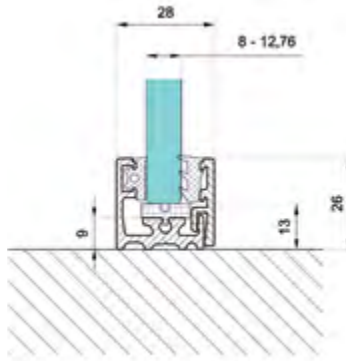

DESCRIPTION	FINISH	LENGTH	CODE
26x28mm base profile & cover	Black	3000mm	G.DK.SG.BK.009

26x28mm Top Profile

Aluminium glass partition system for use on the top. A very fast and easy installation.

Gasket kits sold separately, dependent on glass thickness.

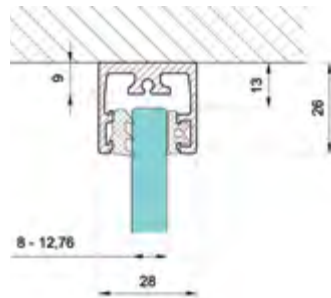

DESCRIPTION	FINISH	LENGTH	CODE
26x28mm top profile	Black	3000mm	G.DK.SG.BK.010

End Caps for 26 x 28mm Profile

End Cap suitable for top and base profile.

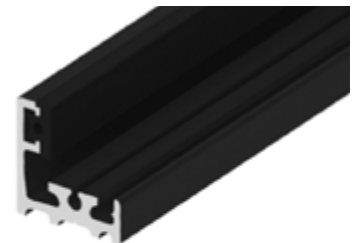

DESCRIPTION	FINISH	UNIT OF SALE	CODE
End cap for 26x28mm profile	Black	Each	G.DK.SG.BK.013

Loft Style

26X28MM SINGLE GLAZED PARTITION SYSTEM

Gasket set for 26x28mm Top & Base Profile

Black 26 x 28mm Top & Base Profile Gaskets to suit 8mm, 10mm, 10.76mm, 12mm and 12.76mm glass.

The gasket labelled A is installed into the profile before the glass and the gasket labelled B is wedged in to secure the glass.

for

G.DK.SG.BK.006

G.DK.SG.BK.010

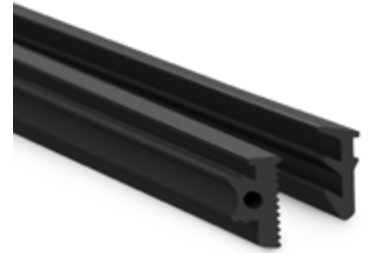

Gasket Labelled A



Gasket Labelled B



DESCRIPTION	FINISH	UNIT OF SALE	CODE
8mm thickness	Black	Per Metre	G.DK.AC.015
10mm thickness	Black	Per Metre	G.DK.AC.017
10.76mm thickness	Black	Per Metre	G.DK.AC.019
12mm thickness	Black	Per Metre	G.DK.AC.021
12.76mm thickness	Black	Per Metre	G.DK.AC.023

Packers for Base Profile

- 26x28mm Base Profile
- 36x38mm Base Profile

These packers slot easily into the base track under the glass to adjust the glass height.

Packers suitable for 26x28mm base profile and 36x38mm base profile. Available in four different thicknesses 3, 4, 5 & 6mm.

for

G.DK.SG.BK.009

G.DK.SG.BK.012

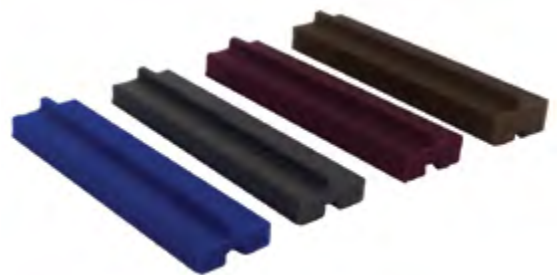
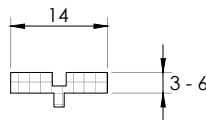

DESCRIPTION	FINISH	UNIT OF SALE	CODE
3mm thickness	Blue	Pack of 10	G.DK.AC.005
4mm thickness	Grey	Pack of 10	G.DK.AC.006*
5mm thickness	Purple	Pack of 10	G.DK.AC.007
6mm thickness	Gold	Pack of 10	G.DK.AC.008*

* **G.DK.AC.006** - recommended for 26x28mm profile
2-3 packers per panel of glass

* **G.DK.AC.008** - recommended for 36x38mm profile
2-3 packers per panel of glass

Loft Style

36X38MM SINGLE GLAZED PARTITION SYSTEM

36 x 38mm Base Profile & Cover

Aluminium glass partition system for use on the bottom and side.

A two part system for very fast and easy installation.

Gasket kits sold separately, dependent on glass thickness.

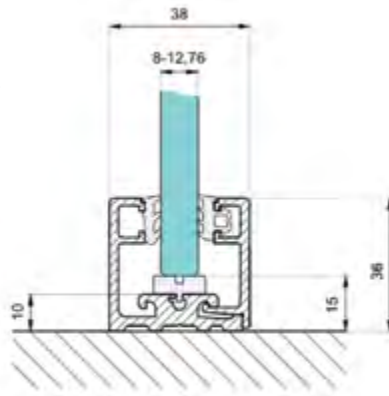

DESCRIPTION	FINISH	LENGTH	CODE
36x38mm base profile & cover	Black	3000mm	G.DK.SG.BK.012

36 x 38mm Top Profile

Aluminium glass partition system for use on the top.

A very fast and easy installation.

Gasket kits sold separately, dependent on glass thickness.

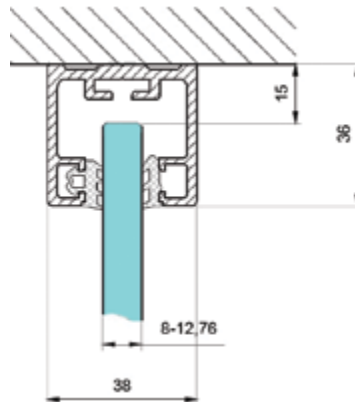

DESCRIPTION	FINISH	LENGTH	CODE
36x38mm top profile	Black	3000mm	G.DK.SG.BK.011

36 x 38mm End Caps

End Caps for 36 x 38mm base or top profiles.

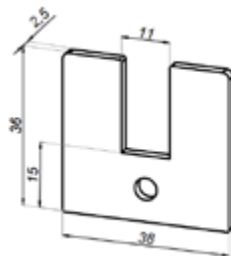

DESCRIPTION	FINISH	UNIT OF SALE	CODE
36x38mm top profile end cap	Black	Each	G.DK.SG.BK.015
36x38mm base profile end cap	Black	Each	G.DK.SG.BK.014

Loft Style

36X38MM SINGLE GLAZED PARTITION SYSTEM

Gasket set for

- 36x38mm Base & Top Profile
- Fixing glass
(Fixed Glass Gasket)

These gaskets suit 8mm, 10mm & 12mm glass and use for 36x38mm base & top profile and for fixed panels on glazed door frame

The gasket labelled A (X) is installed into the profile before the glass and the gasket labelled B (Y) is wedged in to secure the glass.

for

G.DK.SG.BK.011

G.DK.SG.BK.012

G.DK.LOFT.013

G.DK.SG.BK.006



Gasket Labelled A (X)

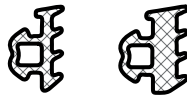

Gasket Labelled B (Y)



DESCRIPTION	GLASS THICKNESS	FINISH	UNIT OF SALE	CODE
36x38mm top & base profile gaskets	8mm	Black	Per Metre	G.DK.AC.034
36x38mm top & base profile gaskets	10mm	Black	Per Metre	G.DK.AC.036
36x38mm top & base profile gaskets	12mm	Black	Per Metre	G.DK.AC.038

Packers for 36x38mm Base Profile - look at page 5 of this catalogue



Loft Style

VERTICAL MULLION & STICK ON MULLION

Vertical Mullion

Creating that old steel type loft style window feel.

The vertical bolt through mullion is easily installed by bolting G.DK.LOFT.008 through the glass joint to G.DK.LOFT.009 and then covered over on both sides using G.DK.LOFT.010.

Ideally used with the 36 x 38mm bottom and top partition profiles.

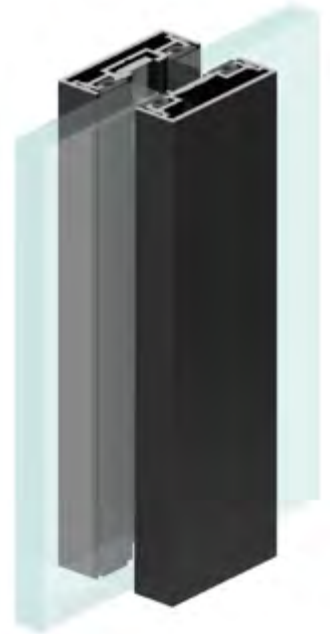
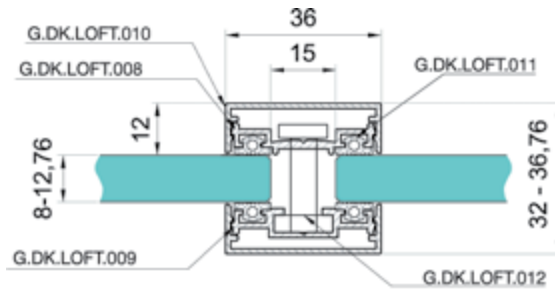

DESCRIPTION	FINISH	UNIT OF SALE	CODE
Vertical mullion	Black	3 metre kit	G.DK.LOFT.006

Stick On Mullion

Creating that old steel type loft style window feel.

This mullion profile can be used both vertically and horizontally and is easily installed by sticking G.DK.LOFT.008 on both sides of the glass using our acrylic tape and then covered over on both sides using G.DK.LOFT.010.

Ideally used with the 36 x 38mm bottom and top partition profiles.

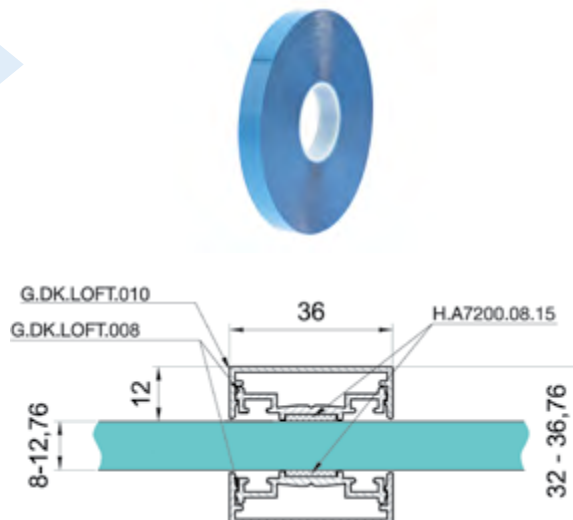

DESCRIPTION	FINISH	UNIT OF SALE	CODE
Stick on mullion	Black	3 metre kit	G.DK.LOFT.007
Crystal clear double side acrylic tape	Clear	20 metre roll	H.A7200.08.15

Loft Style

VERTICAL & HORIZONTAL MULLION COMPONENTS

Vertical & Horizontal Mullion Components

These items are used to create the previous two kits. While the same mullion cover profile is used for both the stick on and bolted vertical mullion the base profiles differ.

The Stick on & Bolt on Base Profile is used on both sides of the glass in a stick on mullion but only on one side in a bolted mullion.

The Bolt On Base Profile Used only with a bolt on mullion installation. This profile holds the nut that allows the previous profile to be bolted too.

The Mullion Cover Profile is used on both sides of the glass in both the bolt on and stick on mullion installations.

The gasket is installed in the base profiles on both sides creating a barrier between the profile and the glass.

Stick on & Bolt on Base Profile

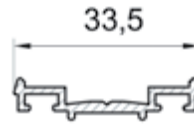

Bolt On Base Profile

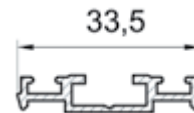

Mullion Cover Profile

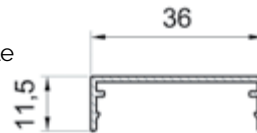

Bolt On Mullion Gasket



DESCRIPTION	FINISH	UNIT OF SALE	CODE
Stick on & bolt on base profile	Black	3000mm	G.DK.LOFT.008
Bolt on base profile	Black	3000mm	G.DK.LOFT.009
Mullion cover profile	Black	3000mm	G.DK.LOFT.010
Bolt on mullion gasket	Black	Per metre	G.DK.LOFT.011

Bolt Set For Bolt On Mullion

Available in three different lengths for different glass thicknesses. It is recommended that 6 bolts be used in a 3 metre length. The Base profile must be drilled to allow the bolt through.



DESCRIPTION	GLASS THICKNESS	UNIT OF SALE	CODE
Bolt On Loft Style Mullion Bolt	8mm	Set of 6	G.DK.LOFT.012.8
Bolt On Loft Style Mullion Bolt	10mm	Set of 6	G.DK.LOFT.012.10
Bolt On Loft Style Mullion Bolt	12mm	Set of 6	G.DK.LOFT.012.12

Loft Style

90° CORNER MULLION

90° Corner Mullion and Installation Bracket

Creating that bulkier and more robust industrial look. This 90° mullion profile is better used with the 36 x 38 partition system. Easily installed using the bracket G.DK.LOFT.014 and the gaskets from the 36 x 38 partition system for your chosen glass thickness.

This corner profile is better installed prior to any glass installation. The glass is then installed in the corner and then working away from it.

Installation Bracket used in conjunction with the above corner mullion for fixing the profile to the ceiling and the floor.

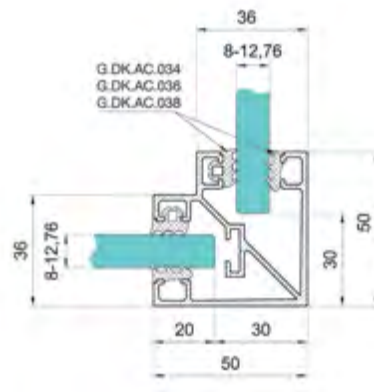

90° Corner Mullion Installation Bracket



DESCRIPTION	FINISH	UNIT OF SALE	CODE
90° corner mullion	Black	Each	G.DK.LOFT.013
90° corner mullion Installation Bracket	-	Each	G.DK.LOFT.014

Fixed Glass Gasket - look at page 7 of this catalogue



Loft Style

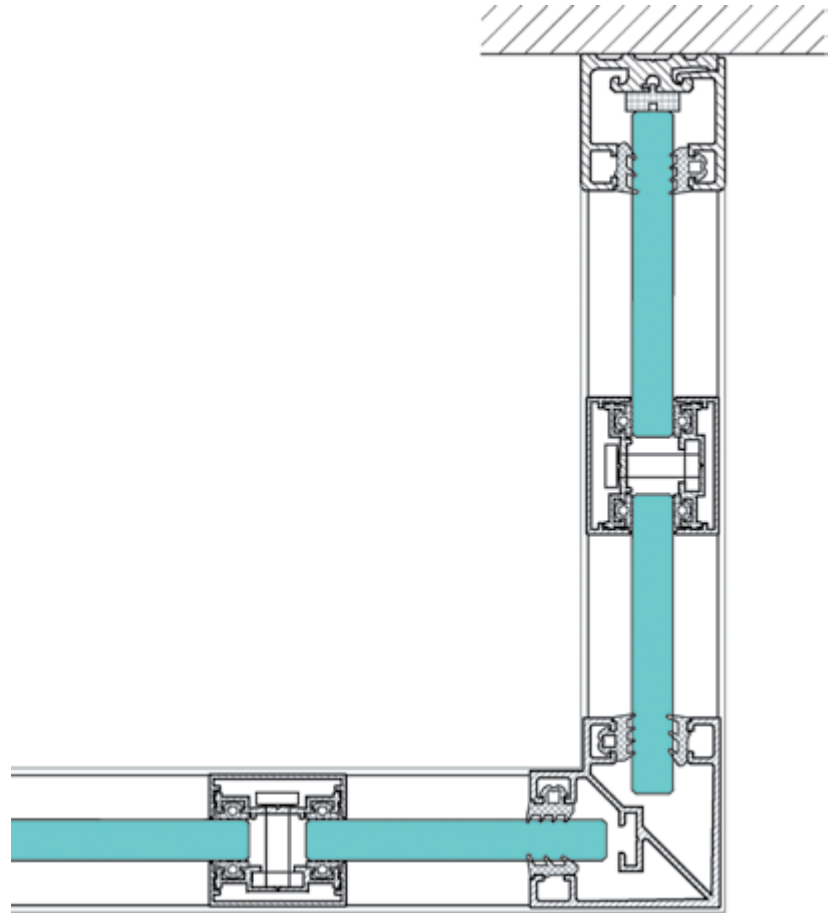

Loft Style

H-TYPE DOOR FRAME AND COMPONENTS

H-Type Door Frame

The H-type aluminium door frame with integrated hinge & receiver profile is suitable for glass thicknesses of 8-10mm. The recommended max door height is 2400mm. Above a height of 2200mm, it is recommended to use 3 hinges.

Installing of the hinges requires no drilling or milling and they can be adjusted in seconds which makes this system a favourite for the installer.

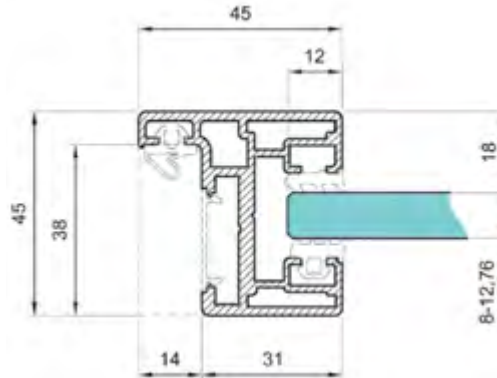

DESCRIPTION

H-Type door frame

FINISH

Black

UNIT OF SALE

Each

CODE

G.DK.SG.BK.006

Fixed Glass Gasket - look at page 7 of this catalogue

Filler Strip - look at page 18 of this catalogue

H-Type Door Frame

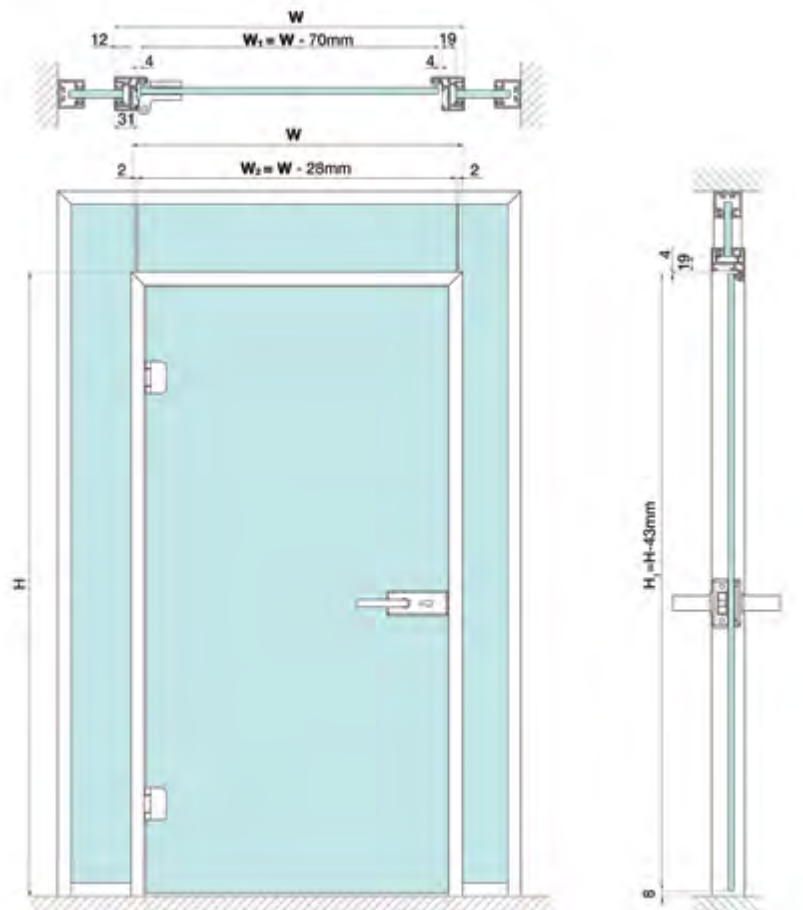

Loft Style

H-TYPE DOOR FRAME AND COMPONENTS

Cleats H-Type Door Frame

- *for the H-Type Glass Door Frame*
- *for H-Type Door Frame to Bottom Track*

H-type door frame cleat kit available in Stainless Steel. Used to securely assemble the H-type door frame in order to keep the joints tight and secure. One kit required per door frame.

Stainless Steel door frame to bottom track cleat. Used to secure each leg of a door frame to the floor or base track. One required for each leg of a door frame.

for
G.DK.SG.BK.006

H-Type door frame cleat kit



Door frame to bottom track cleat



DESCRIPTION	FINISH	UNIT OF SALE	CODE
H-Type door frame cleat kit	Stainless steel	Set	G.DK.AC.004
Door frame to bottom track cleat	Stainless steel	Each	G.DK.AC.026

Dynamik Pre Cut Door Kit

- *850mm x 2057mm*
- *920mm x 2057mm*

Included in the kit are all the cleats needed to assemble, pre mitred corners & gaskets.

Just indicate the glass thickness to be used so that the correct gaskets can be shipped.

Hinges sold separately.

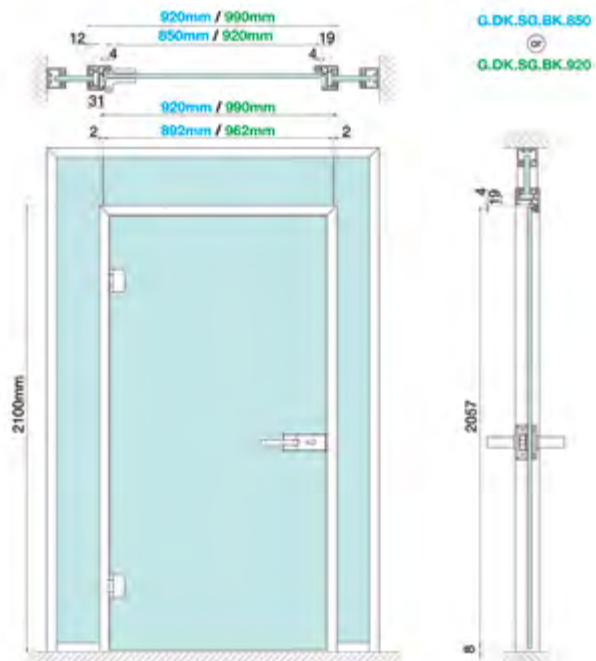

DESCRIPTION	WIDTH	FINISH	UNIT OF SALE	CODE
850mm x 2057mm door frame kit	850mm	Black	Kit	G.DK.SG.BK.850
920mm x 2057mm door frame kit	920mm	Black	Kit	G.DK.SG.BK.920

Loft Style

L & Z TYPE ALUMINIUM DOOR FRAMES AND COMPONENTS

L-Type Door Frame

The L-type aluminium door frame with integrated hinge & receiver profile is suitable for glass thicknesses of 8-10mm. The recommended max door height is 2400mm. Above a height of 2200 mm, it is recommended to use 3 hinges.

This profile is designed in a L type shape to sit in any reveal size over 50mm and create a rebate for the glass door to reduce both noise and air movement.

Installing of the hinges requires no drilling or milling and they can be adjusted in seconds which makes this system a favourite for the installer.

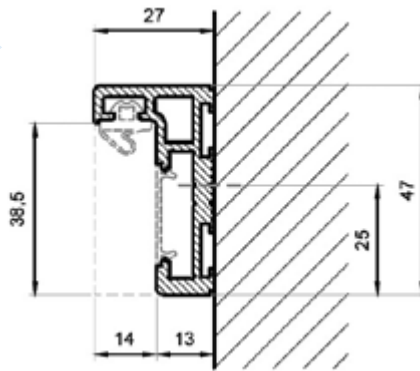

DESCRIPTION

FINISH

UNIT OF SALE

CODE

L-Type door frame

Black

Each

G.DK.SG.BK.004

Z-Type Door Frame

The Z-type aluminium door frame with integrated hinge & receiver profile is suitable for glass thicknesses of 8-10mm. The recommended max door height is 2400mm. Above a height of 2200 mm, it is recommended to use 3 hinges.

This profile is designed in a z type shape to cover the edge of the reveal and create a rebate for the glass door reducing noise and air movement.

Installing of the hinges requires no drilling or milling and they can be adjusted in seconds which makes this system a favourite for the installer.

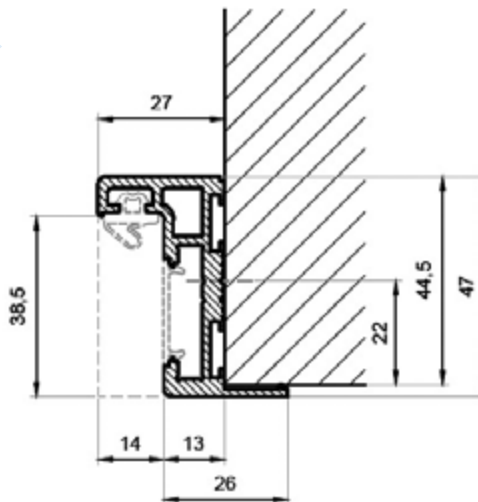

DESCRIPTION

FINISH

UNIT OF SALE

CODE

Z-Type door frame

Black

Each

G.DK.SG.BK.005

Loft Style

L & Z TYPE ALUMINIUM DOOR FRAMES AND COMPONENTS

Cleat Kit for L-Type & Z-Type Aluminium Door Frame For Glass Doors

Designed to reinforce the corners of the assembled door frame ensuring tight and closed joints. One kit required per door frame.

for
G.DK.SG.BK.004
G.DK.SG.BK.005

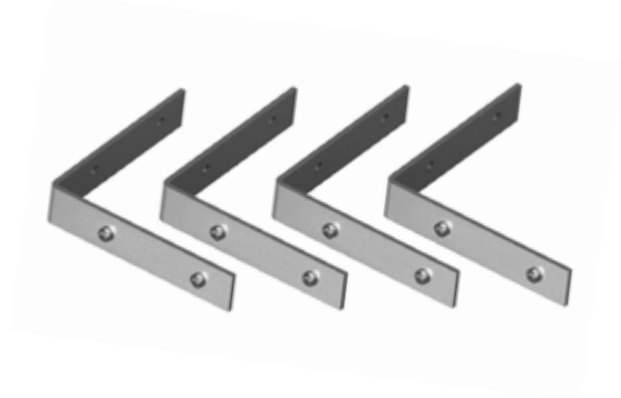

DESCRIPTION	FINISH	UNIT OF SALE	CODE
Cleat Kit type L/Z	Stainless steel	Set	G.DK.AC.003

Glass door rebate gasket - look at page 18 of this catalogue

Filler Strip - look at page 18 of this catalogue

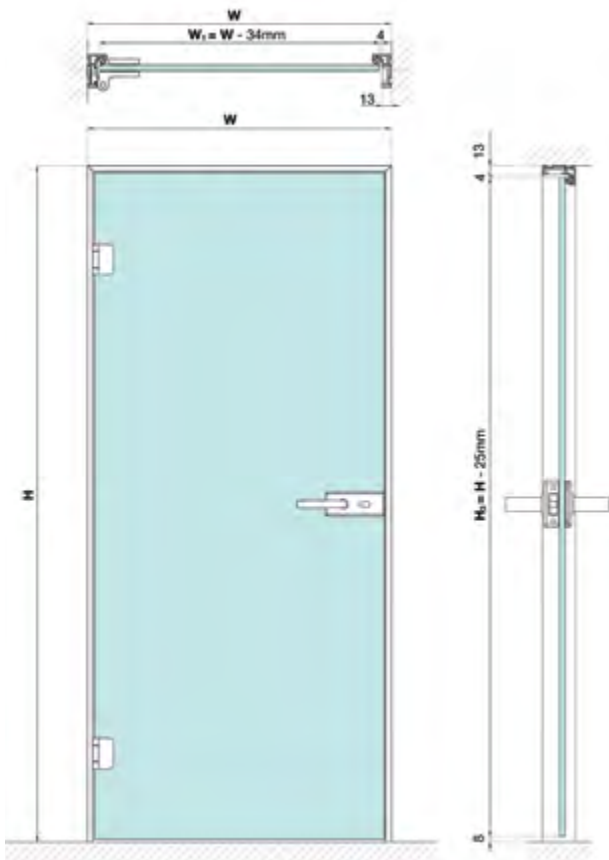

L-Type Door Frame

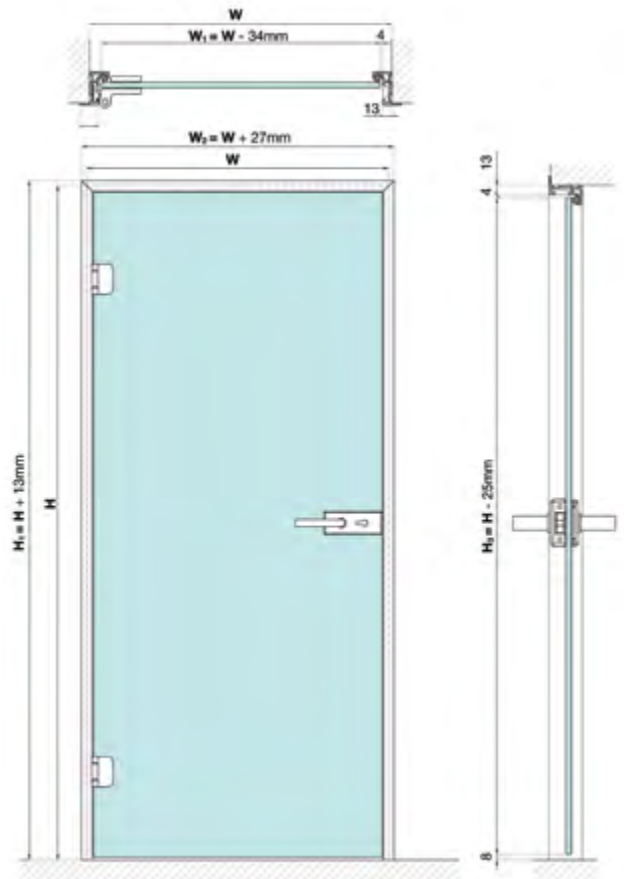

Z-Type Door Frame

Loft Style

REVEAL TYPE GLASS DOOR FRAME SYSTEM AND COMPONENTS

Aluminium Stud/ Wall To Glass Door Frame

This stud/wall to glass door aluminium door frame with integrated hinge & receiver profile is suitable for glass thicknesses of 8-10mm.

The recommended max door height is 2400mm. Above a height of 2200 mm, it is recommended to use 3 hinges.

Suitable when the stud/wall thickness is 100-130mm, 130-160mm & 160-195mm.

This profile is designed in this shape to fit securely into a reveal covering opening edge like an architrave.

The design creates a rebate for the glass door to reduce both noise and air movement.

Installing of the hinges requires no drilling or milling and they can be adjusted in seconds which makes this system a favourite for the installer.

100-130mm Door Frame



130-160mm Door Frame



160-195mm Door Frame

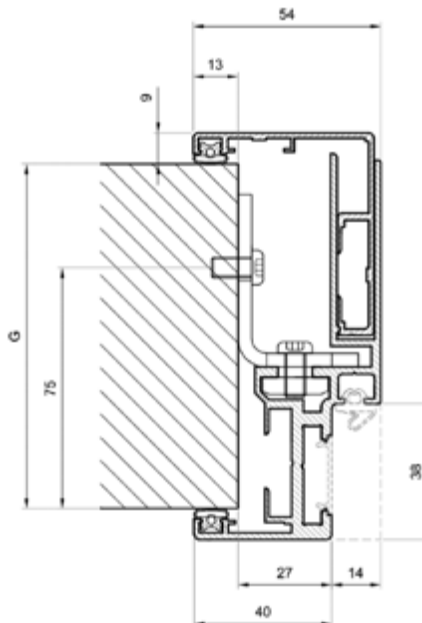

DESCRIPTION	FINISH	UNIT OF SALE	CODE
100-130mm stud to glass door frame	Black	Each	G.DK.SG.BK.001
130-160mm stud to glass door frame	Black	Each	G.DK.SG.BK.002
160-195mm stud to glass door frame	Black	Each	G.DK.SG.BK.003

Loft Style

REVEAL TYPE GLASS DOOR FRAME SYSTEM AND COMPONENTS

Cleats for Stud To Glass Door Frame

- *Cleat Kit For Stud To Glass Door Frame*
- *Adjustable Fixing Brackets For Stud To Glass Door Frame*

Used to securely assemble the stud to glass door frame in order to keep the joints tight and secure. One kit required per door frame.

Adjustable Fixing Brackets for Stud to Glass Door Frame which fixes the frame to the wall. The slotted holes allow for adjustment in the frame in both directions.

Cleat kit available in Stainless steel.

for

G.DK.SG.BK.001

G.DK.SG.BK.002

G.DK.SG.BK.003

Door frame to bottom track cleat



Adjustable fixing brackets for stud to glass door frame

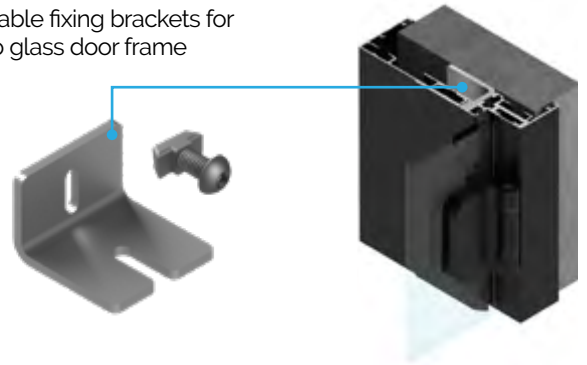

DESCRIPTION	FINISH	UNIT OF SALE	CODE
H-Type door frame cleat kit	Stainless steel	Set	G.DK.AC.001
Adjustable fixing brackets for stud to glass door frame	Stainless steel	Each	G.DK.AC.002

Stud To Glass Door Frame

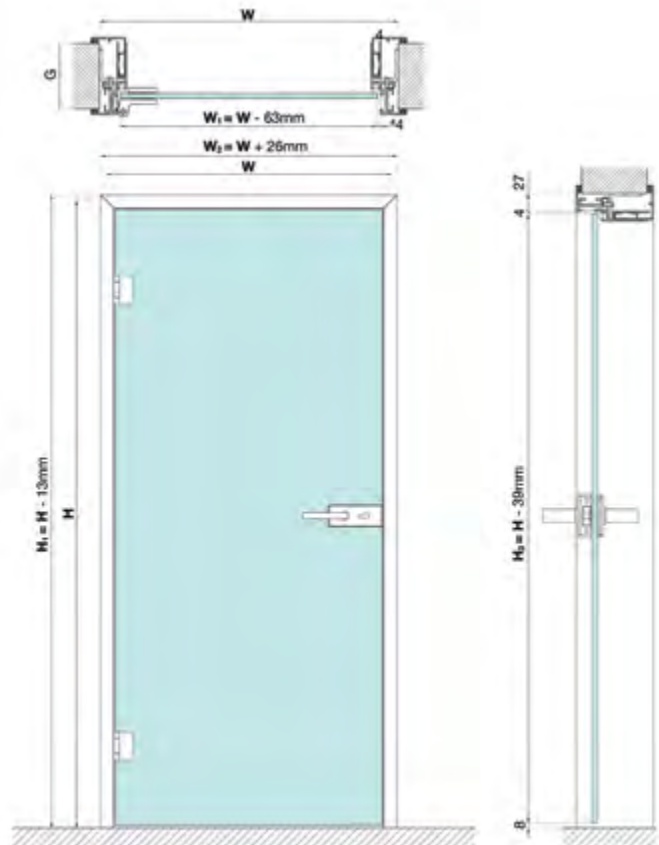

Loft Style

GASKETS AND STRIP

Glass Door Rebate Gaskets

Gaskets used where the glass door meets the aluminium rebate of the door frame profile ensuring a soft close and reduced noise and air movement.

Available for 8 or 10mm glass thickness.

for

G.DK.SG.BK.001

G.DK.SG.BK.002

G.DK.SG.BK.003

G.DK.SG.BK.004

G.DK.SG.BK.005

G.DK.SG.BK.006



DESCRIPTION	GLASS THICKNESS	FINISH	UNIT OF SALE	CODE
Glass door rebate gasket	8mm	Black	Per metre	G.DK.AC.011
Glass door rebate gasket	10mm	Black	Per metre	G.DK.AC.012

Filler Strip

The door frame filler strip is cut and easily snapped in to place to cover the hinge and receiver tracks on all the door frame profiles.

Cut and snap in the filler strip wherever required for a flush and seamless finish.

for

G.DK.SG.BK.001

G.DK.SG.BK.002

G.DK.SG.BK.003

G.DK.SG.BK.004

G.DK.SG.BK.005

G.DK.SG.BK.006



DESCRIPTION	FINISH	UNIT OF SALE	CODE
Filler strip	Black	6000mm	G.DK.SG.BK.007

Aluminium Wall to Glass Door Frame Gasket

This gasket is used to create a seal where the door frame meets the wall.

for

G.DK.SG.BK.001

G.DK.SG.BK.002

G.DK.SG.BK.003

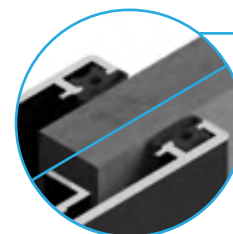

DESCRIPTION	FINISH	UNIT OF SALE	CODE
Aluminium wall to glass door frame gasket	Black	Per metre	G.DK.AC.031

Loft Style

90° PROFILES, 180° PROFILES

Loft Style 90° Corner Profiles

Available for 8 or 10mm thick glass. These 90° corners are easily installed using a silicone type adhesive.

Used vertically to form a metal frame effect for that genuine look and feel.

Can be used with any of our Dynamik partition profiles.

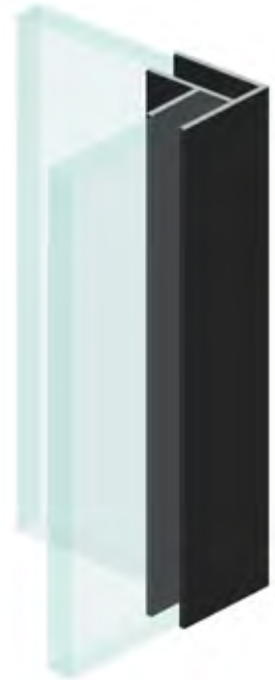
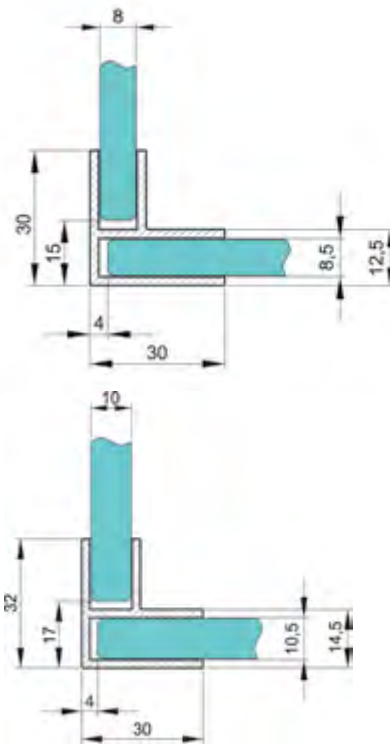

DESCRIPTION	FINISH	GLASS THICKNESS	LENGTH	CODE
90° H- profile	Black	8mm	3000mm	G.DK.LOFT.020
90° H- profile	Black	10mm	3000mm	G.DK.LOFT.021

Loft Style 180° Profiles

Available for 8 or 10mm thick glass. These 180° corners are easily installed using a silicone type adhesive.

Used vertically on the joint of two glass panes to form a metal frame effect for that genuine look and feel.

Can be used with any of our Dynamik partition profiles.

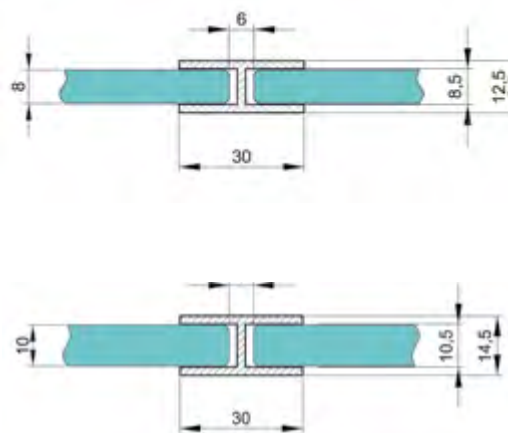

DESCRIPTION	FINISH	GLASS THICKNESS	LENGTH	CODE
180° H- profile	Black	8mm	3000mm	G.DK.LOFT.022
180° H- profile	Black	10mm	3000mm	G.DK.LOFT.023

Loft Style

DOOR PROFILES, HINGES

Loft Style Door Perimeter and Notched U Profile

Loft style perimeter U profile suitable for 8mm glass thickness. Easily attached to the glass with suitable adhesive/silicone.

Loft Style Door Perimeter Notched U Profile matches exactly with the above profile only that it is notched for use with our Loft Style Lever Locks. Only for use on the locking side and available in a left or right hand version. Easily attached to the glass with suitable adhesive/silicone.

Mitre the corners at 45° for that seamless professional look.



Loft style door perimeter U profile



Loft style door notched U profile

DESCRIPTION	FINISH	GLASS THICKNESS	LENGTH	CODE
Loft style door perimeter U profile	Black	8mm	2500mm	G.DK.LOFT.001
Loft style door notched U profile left	Black	8mm	2500mm	G.DK.LOFT.002
Loft style door notched U profile right	Black	8mm	2500mm	G.DK.LOFT.003

Loft Style Dynamik Door Hinge

Specially designed to work in harmony with the loft style perimeter profile.

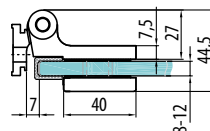
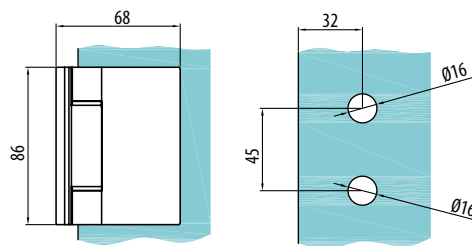

DESCRIPTION	FINISH	GLASS THICKNESS	UNIT OF SALE	CODE
Loft style Dynamik door hinge	Black	8mm	Each	G.DK.LOFT.004

Loft Style

ACCESSORIES

Lock with knob

Made of high quality stainless steel, it resists rust and corrosion. The keyless design makes it easy to secure the glass door and prevent it from being opened.

Modern and elegant installed on the under side of the door. Easy to install, no need to punch holes in the glass, just punch a round hole in the ground.

Safe and convenient the door lock has a twistable handle to easily lock the glass door. The door lock is suitable for 8-12mm glass thickness and the gap between the glass door and the ground is 12mm.

Note: This Lock Only fits for the Thickness of a 8-12mm Glass Door.

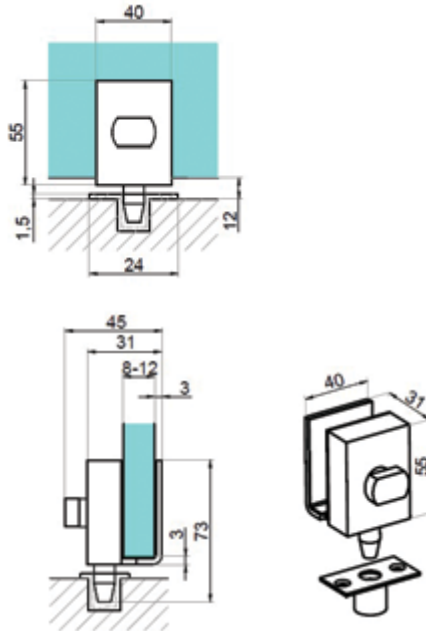

DESCRIPTION

Lock with knob

FINISH

Black

UNIT OF SALE

Each

CODE

Loft Style Stick On Grid Profile

This 19mm x 1.8mm thick aluminium profile that can easily be used horizontally or vertically to create that loft look. Ideally used with our special 0.75mm thick acrylic tape in the slotted area to the back of the profile to ensure a genuine look and feel.

Can be used with any of our Dynamik partition profiles.

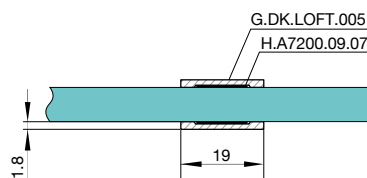

DESCRIPTION

Loft style stick on grid profile

FINISH

Black

UNIT OF SALE

3000mm

CODE

G.DK.LOFT.005

Crystal clear double side acrylic tape

Clear

20 metre roll

H.A7200.09.07

Loft Style

ACCESSORIES

Magnetic Catch Lever Lock-Without Lock

Suitable for both 8mm and 10mm glass thickness. Square hole for all lever handles with 8mm square spindle. For left hand or right hand installations. Suitable for use with the magnetic receiver KLL501KF-B. Due to the fact that the magnetic latch is only activated when it meets the receiver it does not strike the frame causing noise or damage.

For use with the Dynamik door frame profiles.

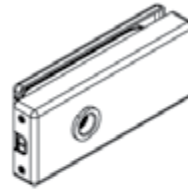
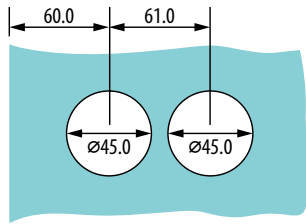
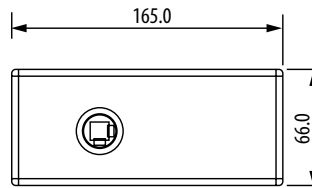

DESCRIPTION

Magnetic catch lever lock- without lock

FINISH

Black

UNIT OF SALE

Each

CODE

KLL501M-WL-B

Magnetic Catch Lever Lock-Lockable

Suitable for both 8mm and 10mm glass thickness. Square hole for all lever handles with 8mm square spindle. Prepared for euro cylinders so that it can be securely locked by key or internally by thumb turn. For left hand or right hand installations. Suitable for use with the magnetic receiver KLL501KF-B. Due to the fact that the magnetic latch is only activated when it meets the receiver it does not strike the frame causing noise or damage.

For use with the Dynamik door frame profiles.

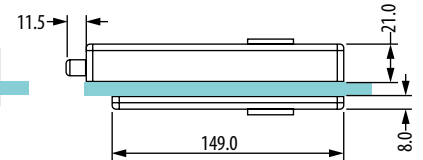
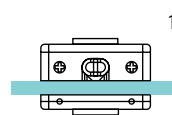
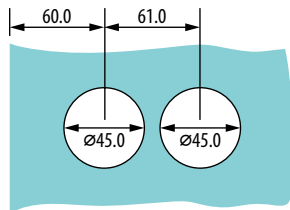
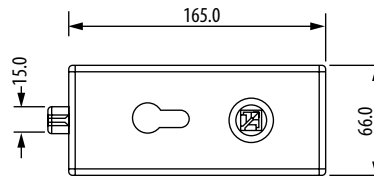

Kg125ST.DK.01



Kg125ST.DK.02



DESCRIPTION

Magnetic catch lever lock-lockable

FINISH

Black

UNIT OF SALE

Each

CODE

KLL501M-B

Thumb turn euro cylinder (door opening in)

Satin chrome

Each

Kg125ST.DK.01

Thumb turn euro cylinder (door opening out)

Satin chrome

Each

Kg125ST.DK.02

Loft Style

ACCESSORIES

Small Magnetic Catch Lever Lock-Without Lock

Suitable for both 8mm and 10mm glass thickness. Square hole for all lever handles with 8mm square spindle. For left hand or right hand installations. Suitable for use with the magnetic receiver KLL501KF-NA. Due to the fact that the magnetic latch is only activated when it meets the receiver it does not strike the frame causing noise or damage. For use with the Dynamik door frame profiles.

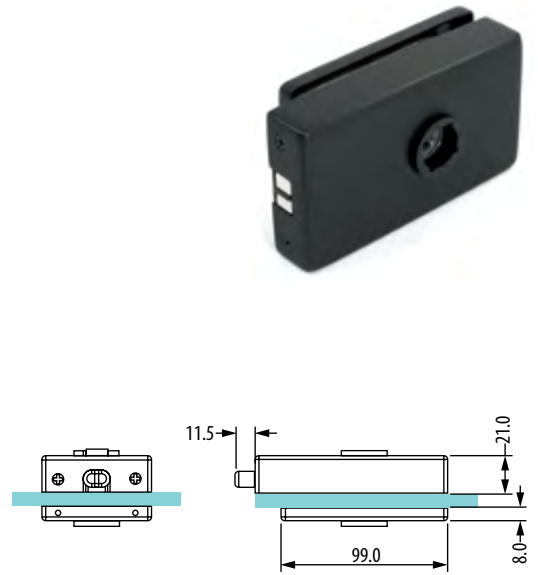
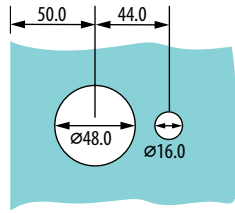
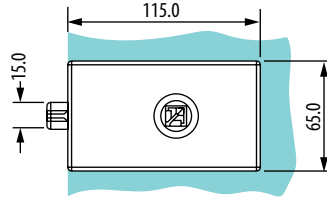

DESCRIPTION

FINISH

UNIT OF SALE

CODE

Small magnetic catch lever lock- without lock

Black

Each

KLL801M-B

Magnetic Lever Lock Frame Receiver

Installed in seconds in any of our Dynamik door frame systems without the need for any cut outs or milling. Works with any of the above magnetic locks.

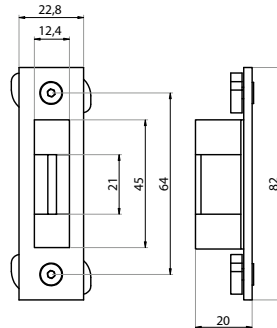

DESCRIPTION

FINISH

UNIT OF SALE

CODE

Magnetic lever lock frame receiver

Black

Each

KLL501KF-B

Lever Handles

Supplied in SUS 304 Stainless Steel. 8mm square spindle for all lever locks. Suitable for use with any of the above magnetic locks.

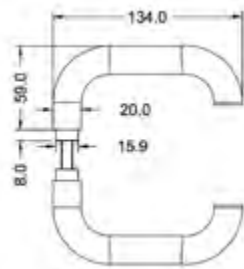

DESCRIPTION

FINISH

UNIT OF SALE

CODE

Lever handles

Black

Each

KLLD.DK.02.B



United Kingdom

Telephone: 0800 975 3436

Email: sales@glassparts.co.uk

www.glassparts.co.uk

Republic of Ireland

Telephone: +353 505 45125

Email: sales@glassparts.ie

www.glassparts.ie

All images portrayed in this catalogue should not be reproduced without specific written permission from GlassParts UK Ltd. Images, designs and finishes are for illustrative purposes only and may differ when manufactured. We reserve the right to amend or withdraw any products within this catalogue without prior notice. Finishes shown in this catalogue should be used for guidance only. Copyright GlassParts UK Ltd © 2023