

**Complete 316 Stainless Steel Canopy Kit for max 13.5mm Glass ( Model: K.CAN.LIGHT.KIT )**

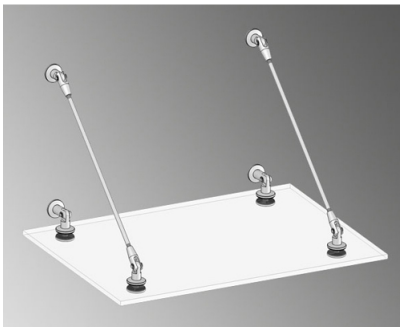

- This kit includes all the hardware that you need to create a modern, functional architectural canopy.
- Maximum glass dimensions of 1500 wide by 1100 deep and with a maximum glass thickness of 13.5mm.
- Included in this kit is, 2 Glass To Wall Brackets, 2 Wall to Tie Rod Brackets, 2 Tie Rods & 2 Tie Rod to Glass Brackets.
- 316 grade stainless steel makes it suitable for even the most harsh outdoor environments.
- Alternative systems available for heavier glass and larger pieces.
- K.CAN.LIGHT.KIT parts are NOT interchangeable with K.CAN.ARCADE System. They are different systems.

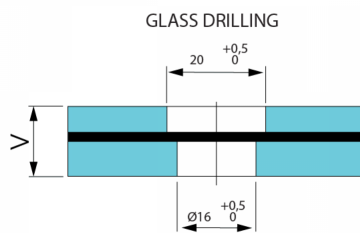

**Attributes:**

**Product Code:** K.CAN.LIGHT.KIT

**Unit Of Sale:** Kit

	GLASS THICKNESS LAMINATED TEMPERED (MM)		MAX. GLASS DIMENSION
	5.5	6.6	
PA max	800	1000	MAX. GLASS 1500 X 1100
PA max	700	800	
PA max	200	250	
PA max			

**TENSION ROD**

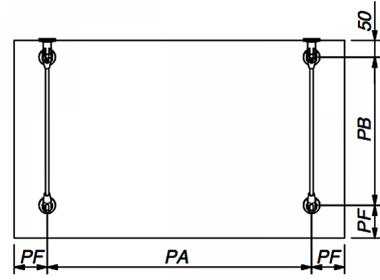
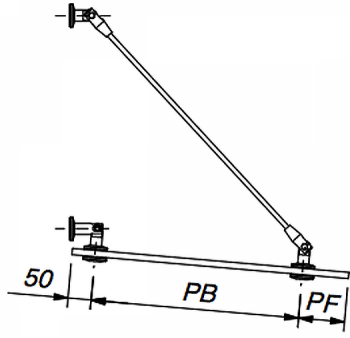
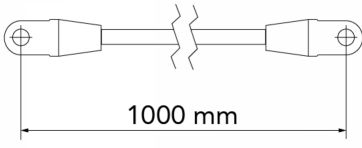

**GUSSET**

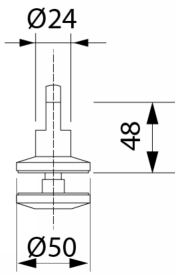

**TOP BRACKET**

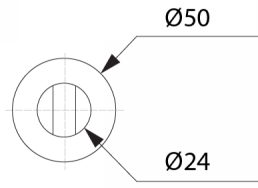

**BOTTOM BRACKET**

